

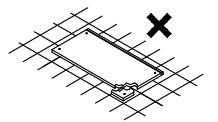

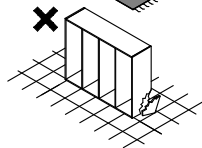

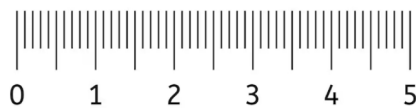

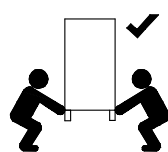

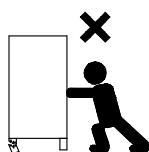
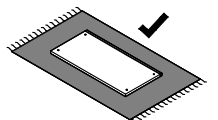
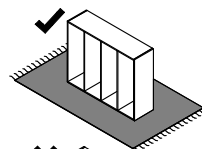
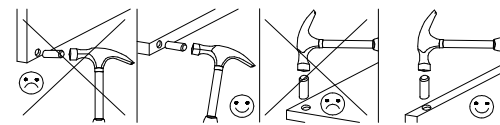
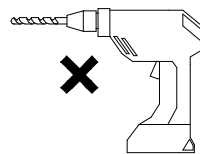
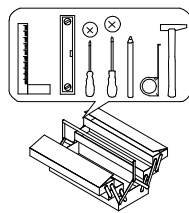
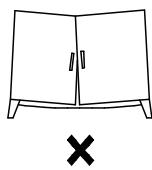
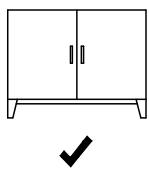
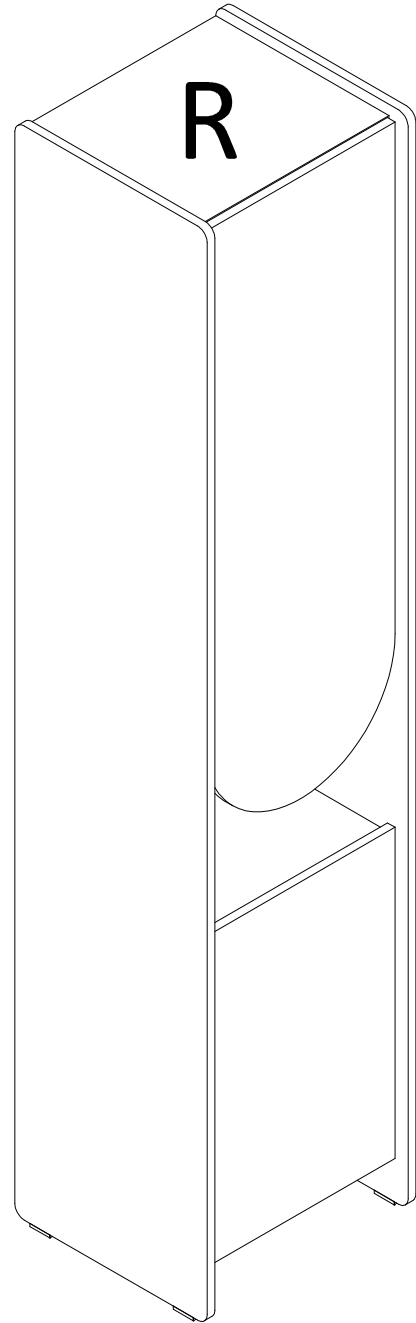
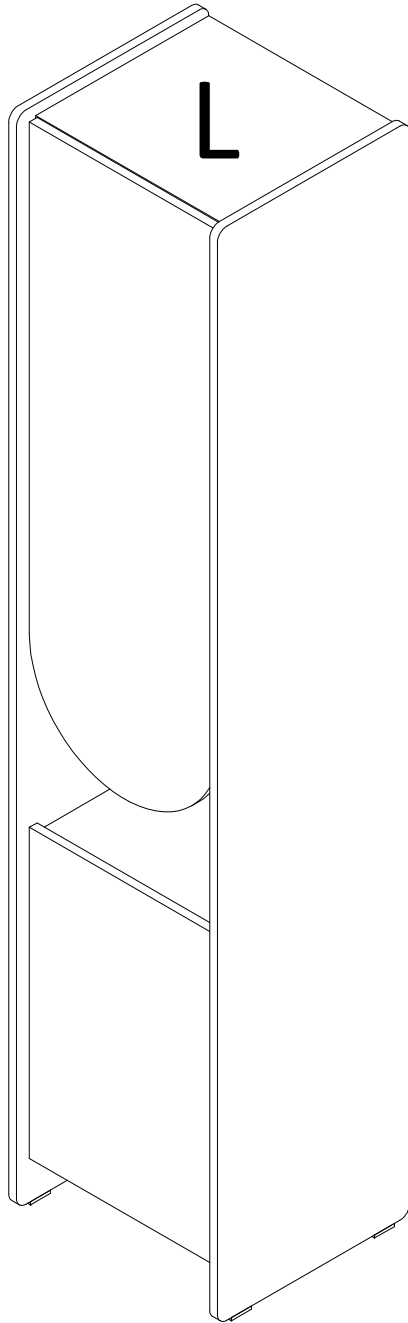
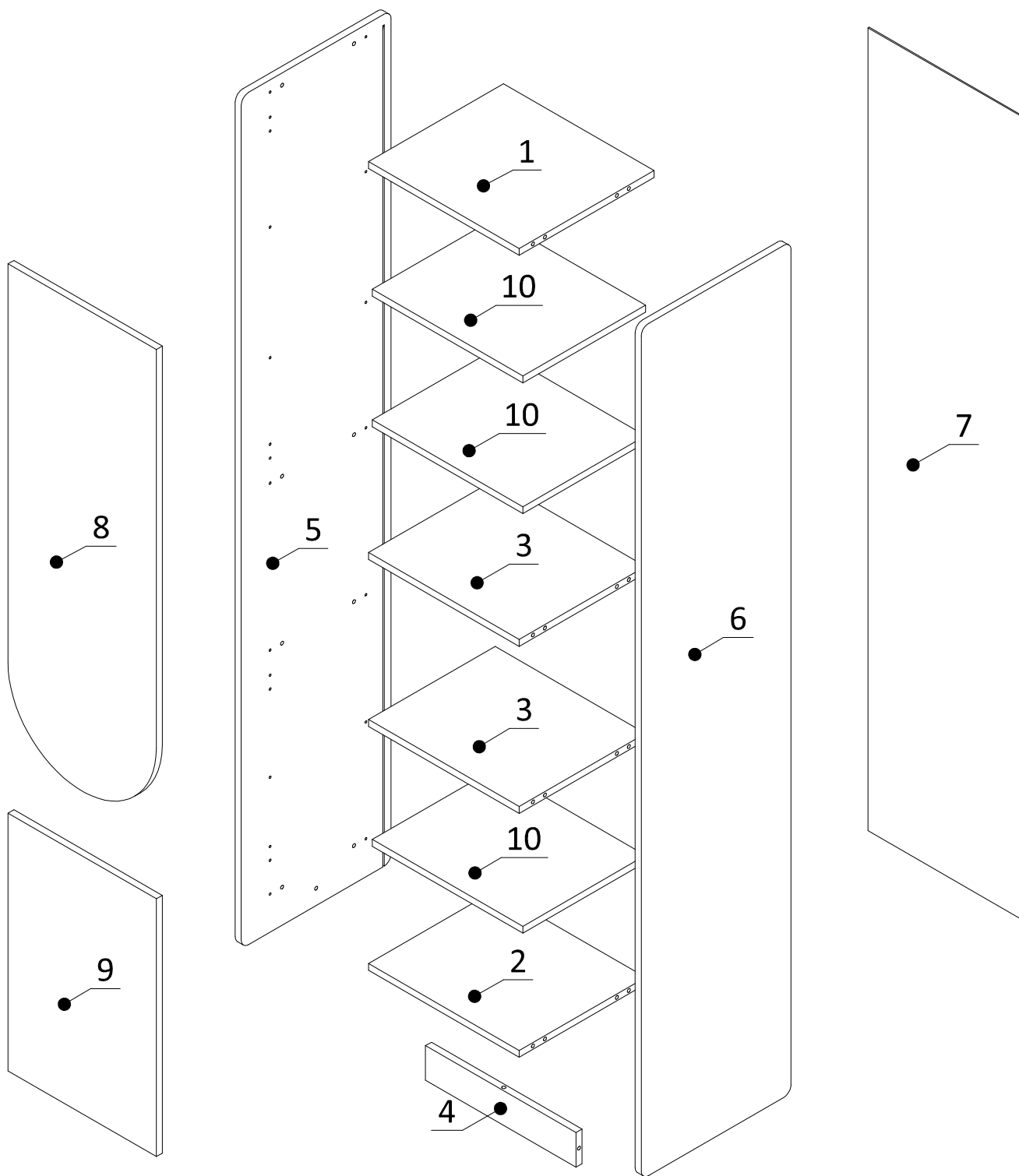

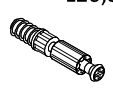
LEXI R-4

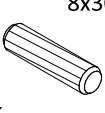
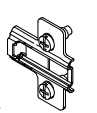
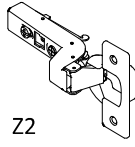



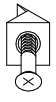
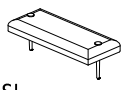

 15/12 M	 L20,3 T	 4x16 W4
16x	16x	8x

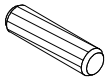

 8x30 K	 PZ	 Z2	 Z5	 P	 ZM	 2x20 G	 S	 SL	 PS
19x	4x	4x	8x	12x	16x	12x	7x	4x	1x

1

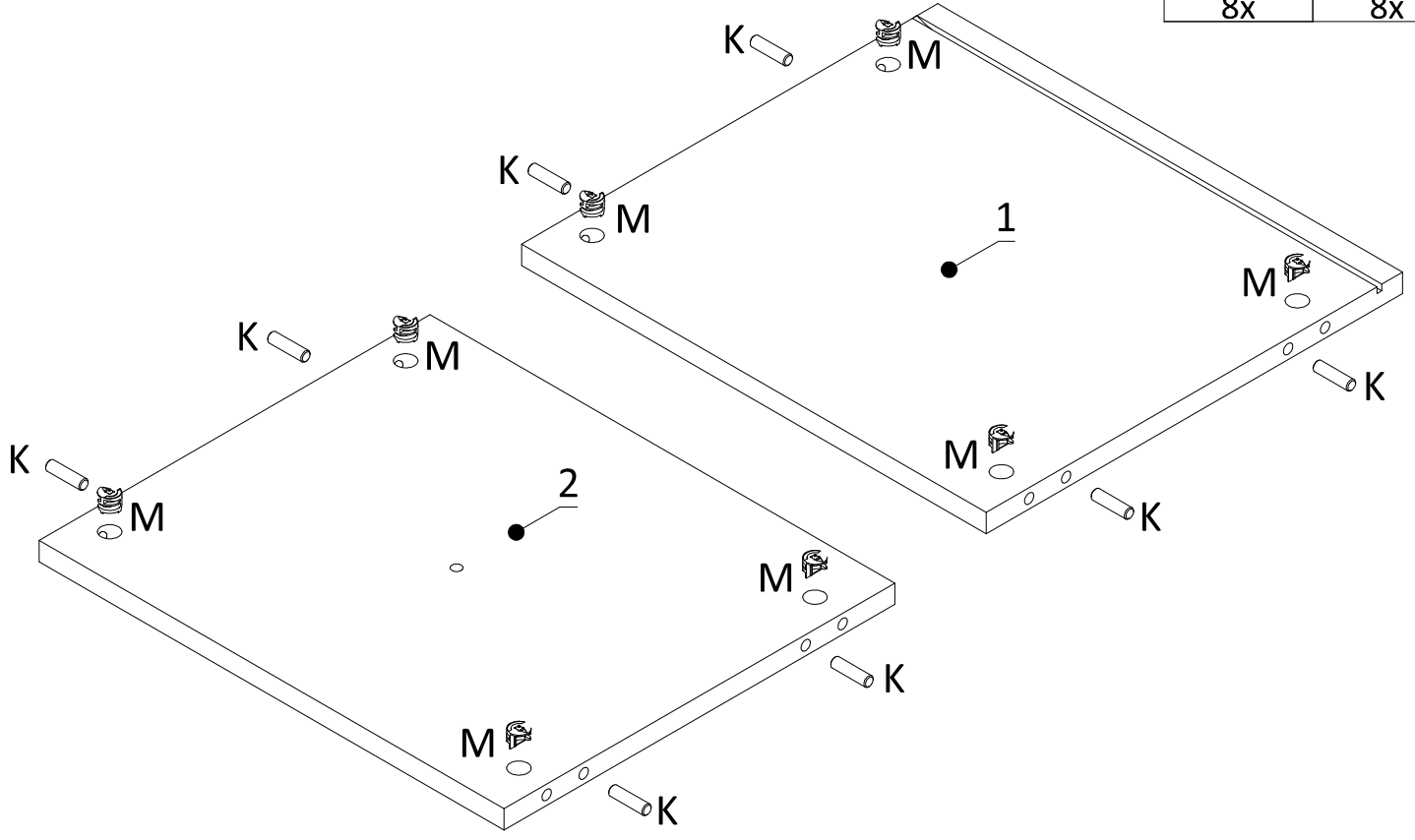
	
K	M
8x	8x



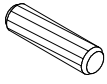

2

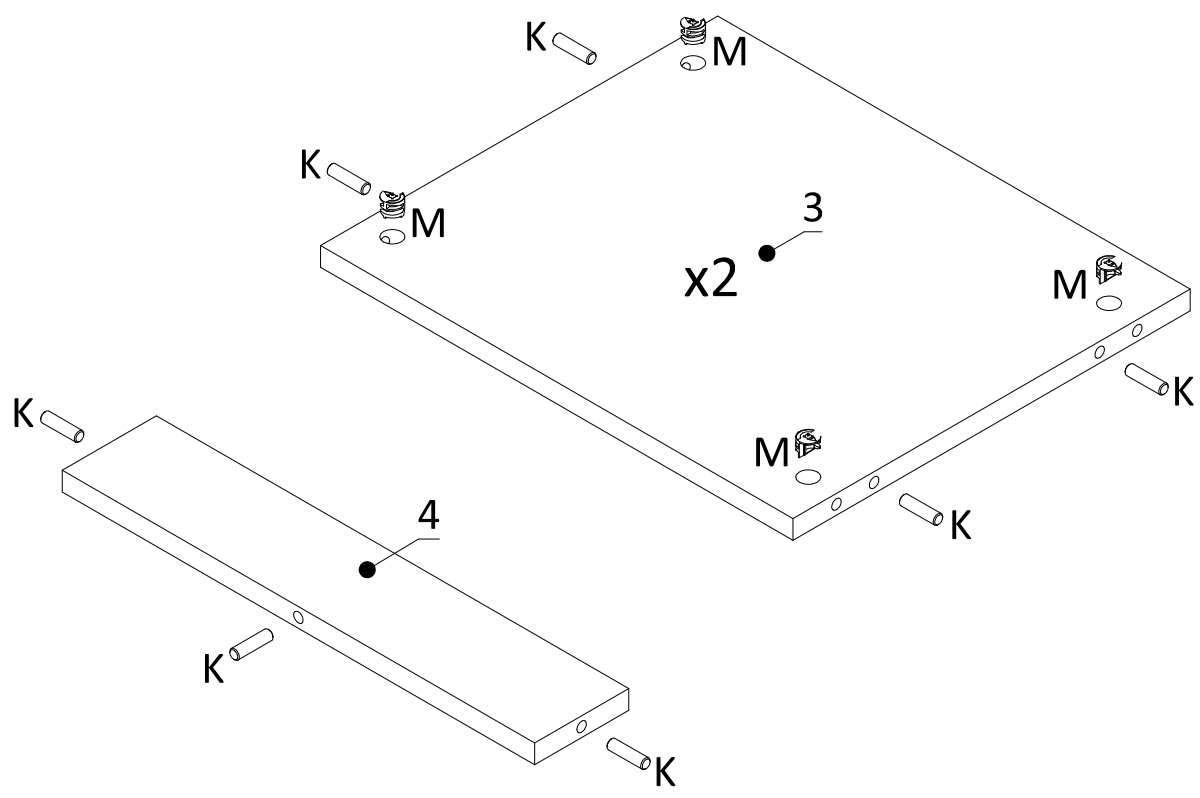
	
K	M
11x	8x



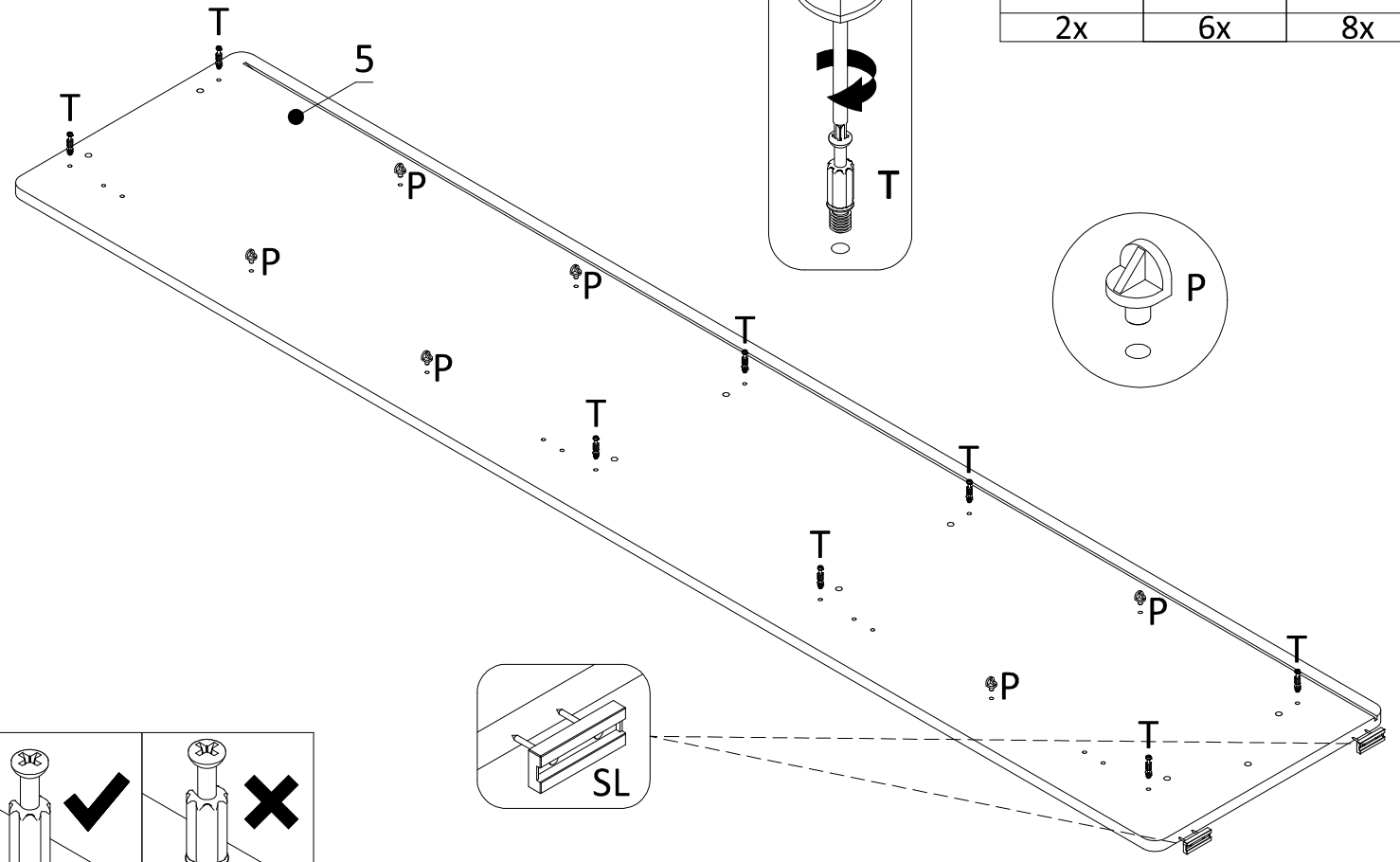

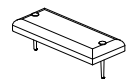
3

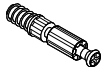

 SL	 P	 T
2x	6x	8x

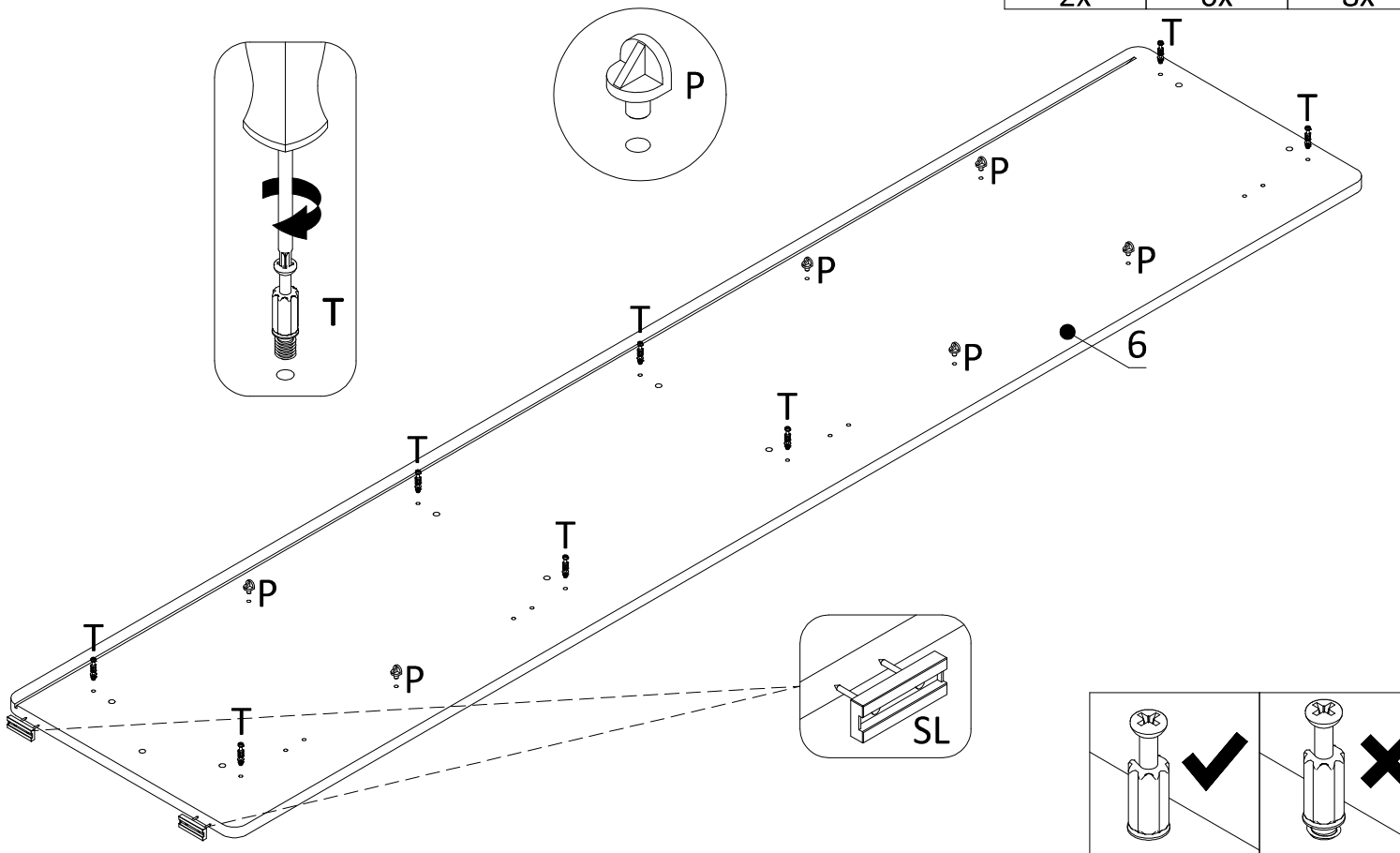
4

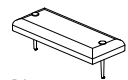

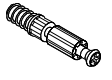
 SL	 P	 T
2x	6x	8x

5 Option L

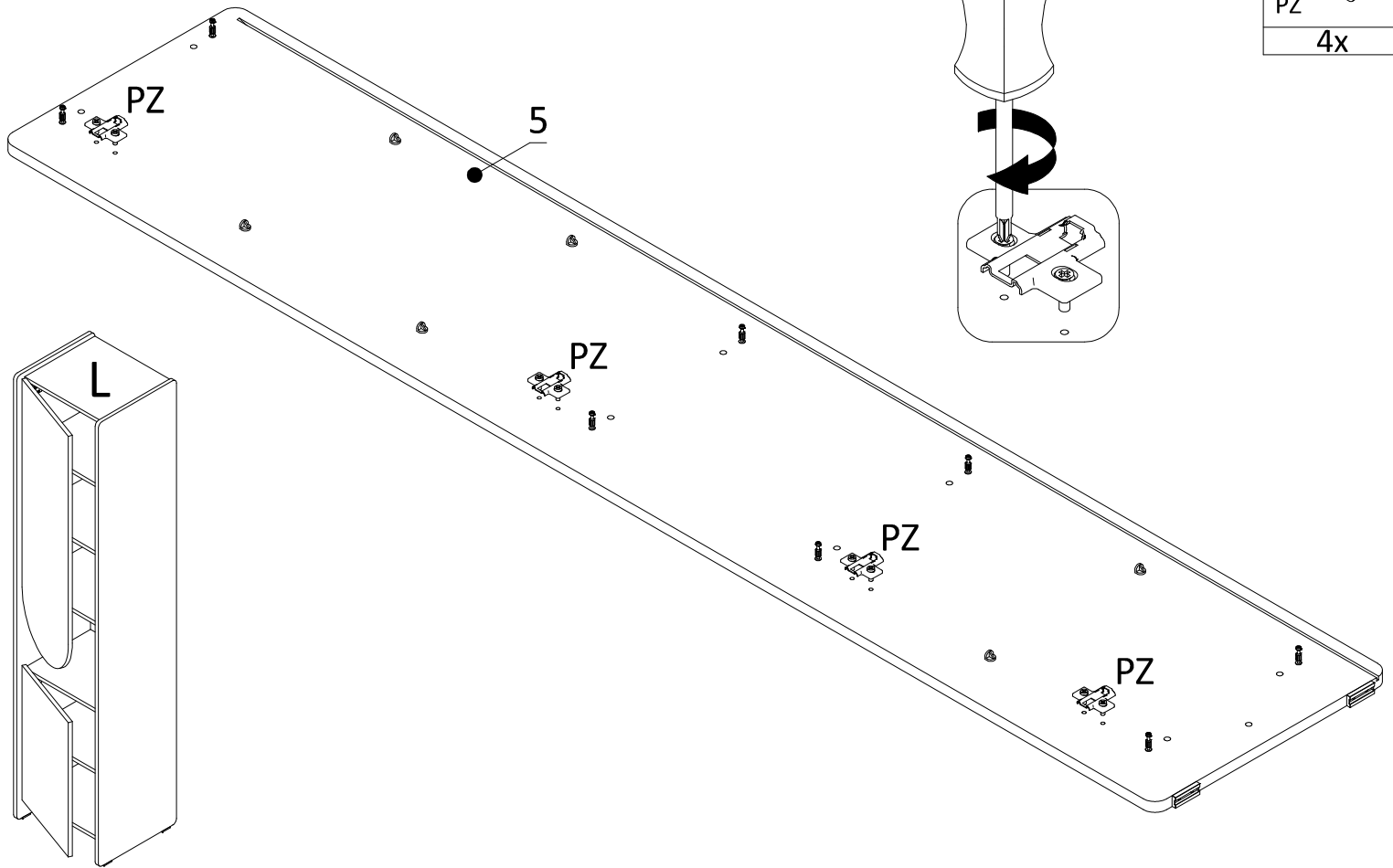

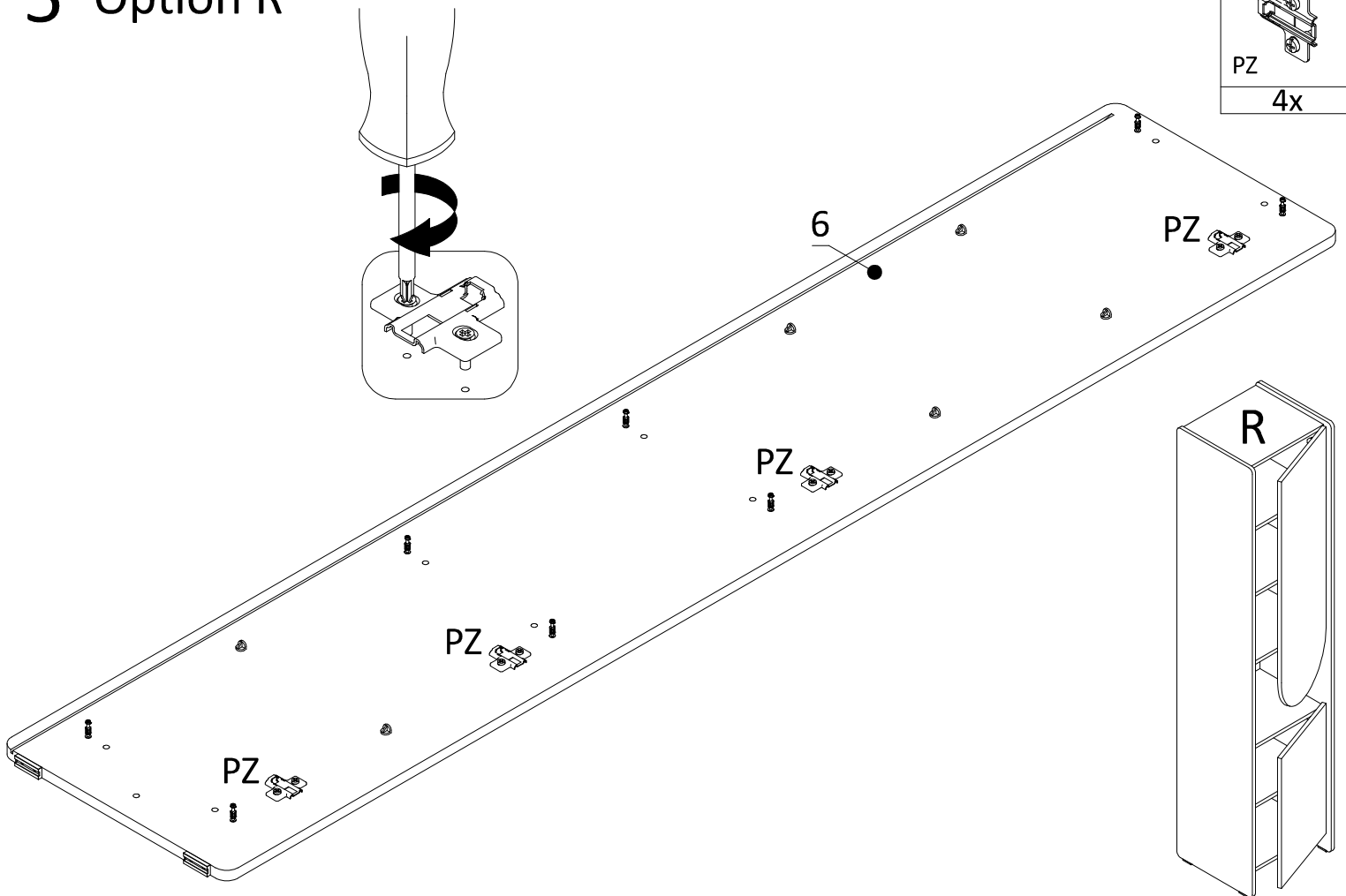

5 Option R



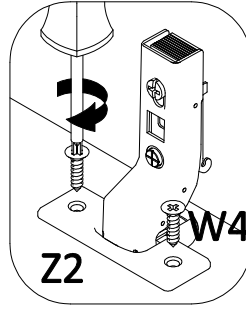
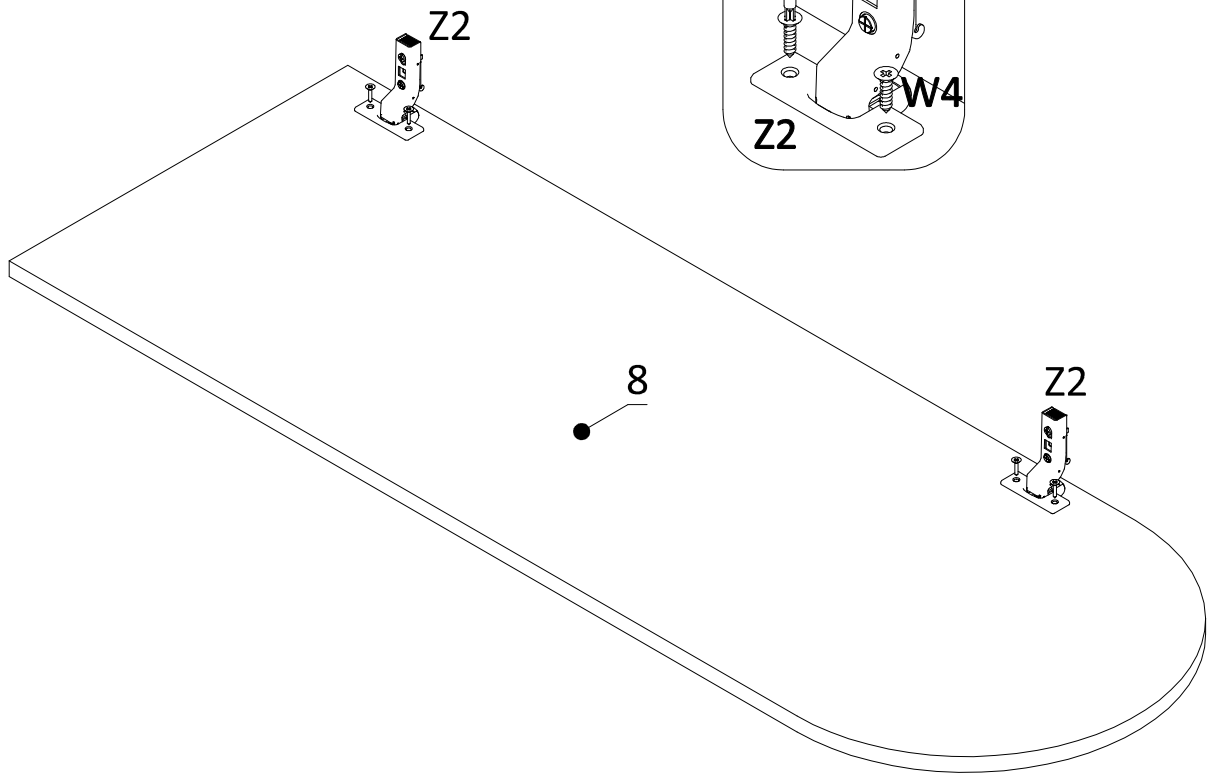

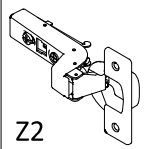
6 Option L



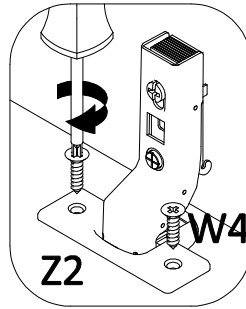
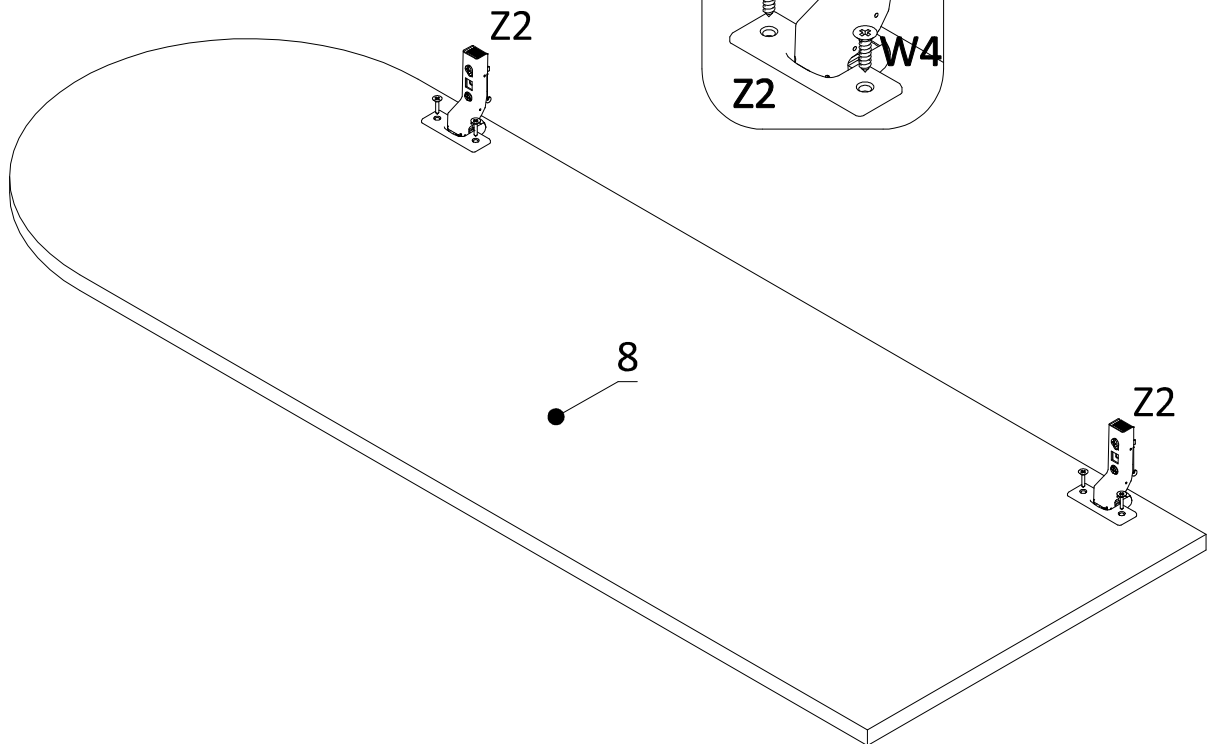

	
Z2	W4
2x	4x

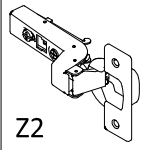
6 Option R

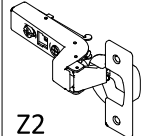

	
Z2	W4
2x	4x

7

	
Z2	W4
2x	4x

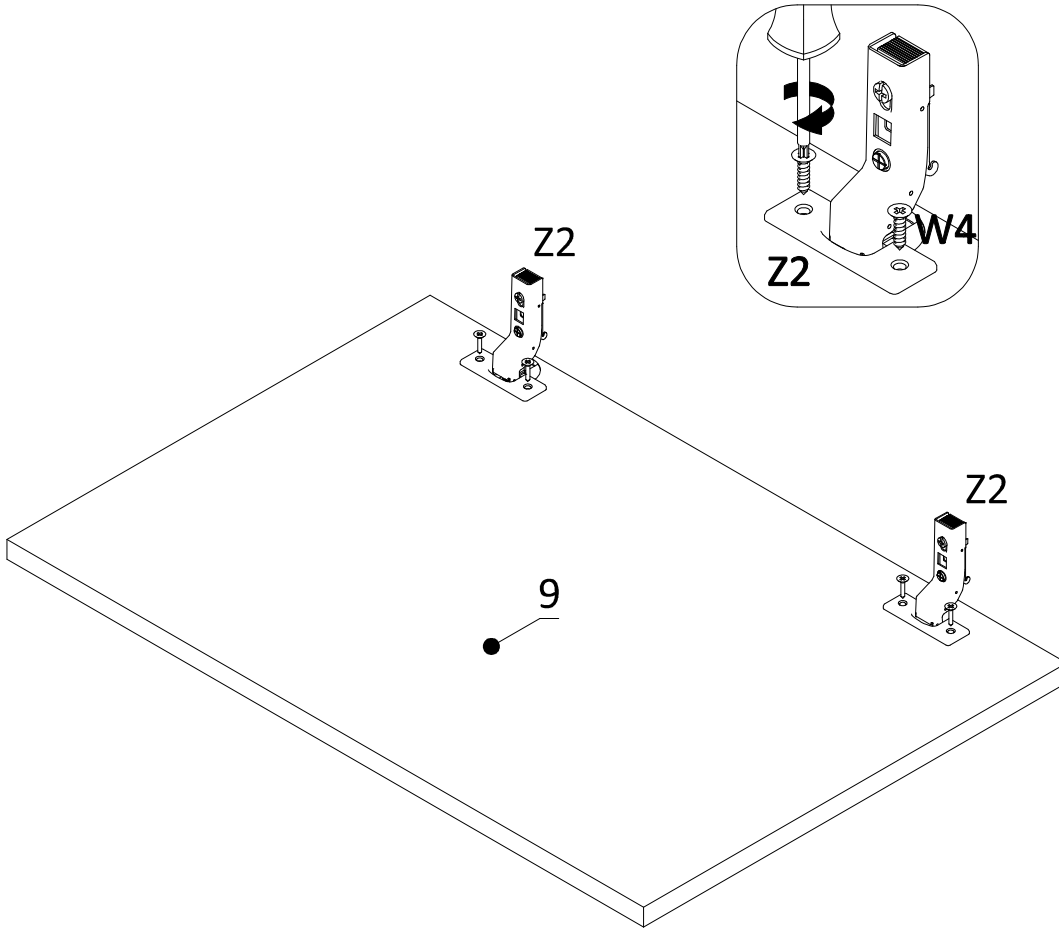

8

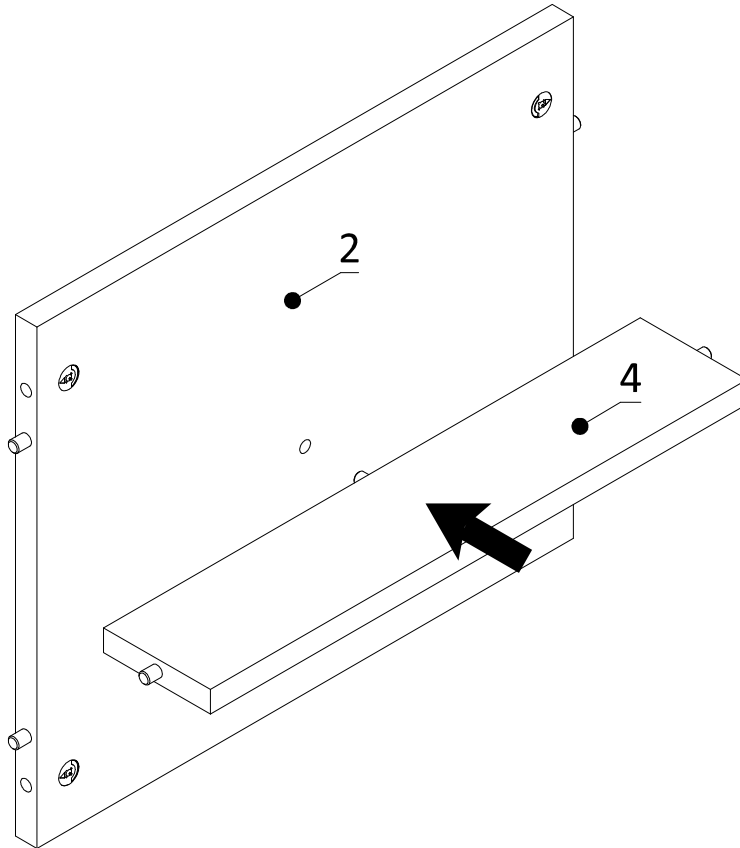

9

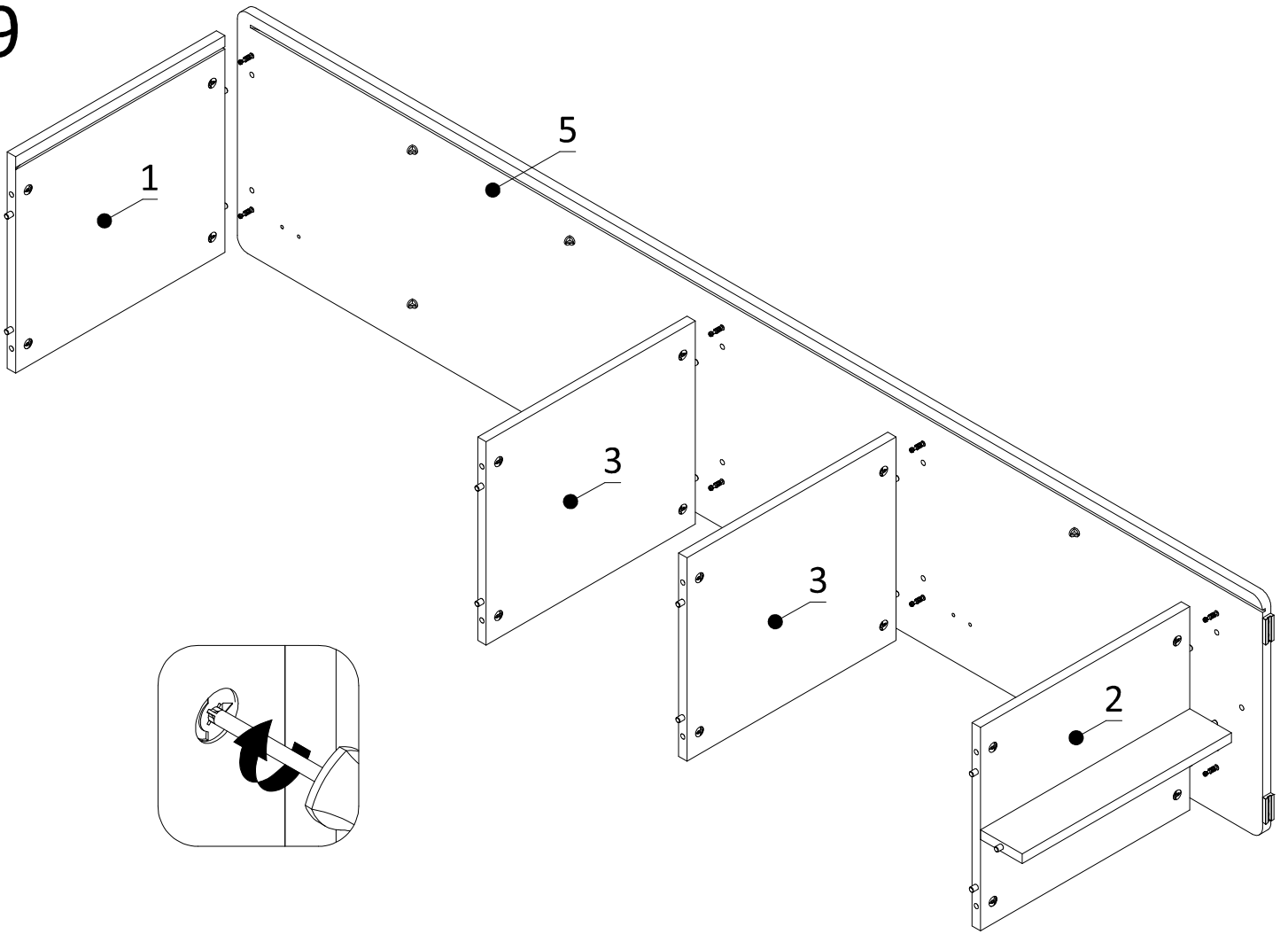

10

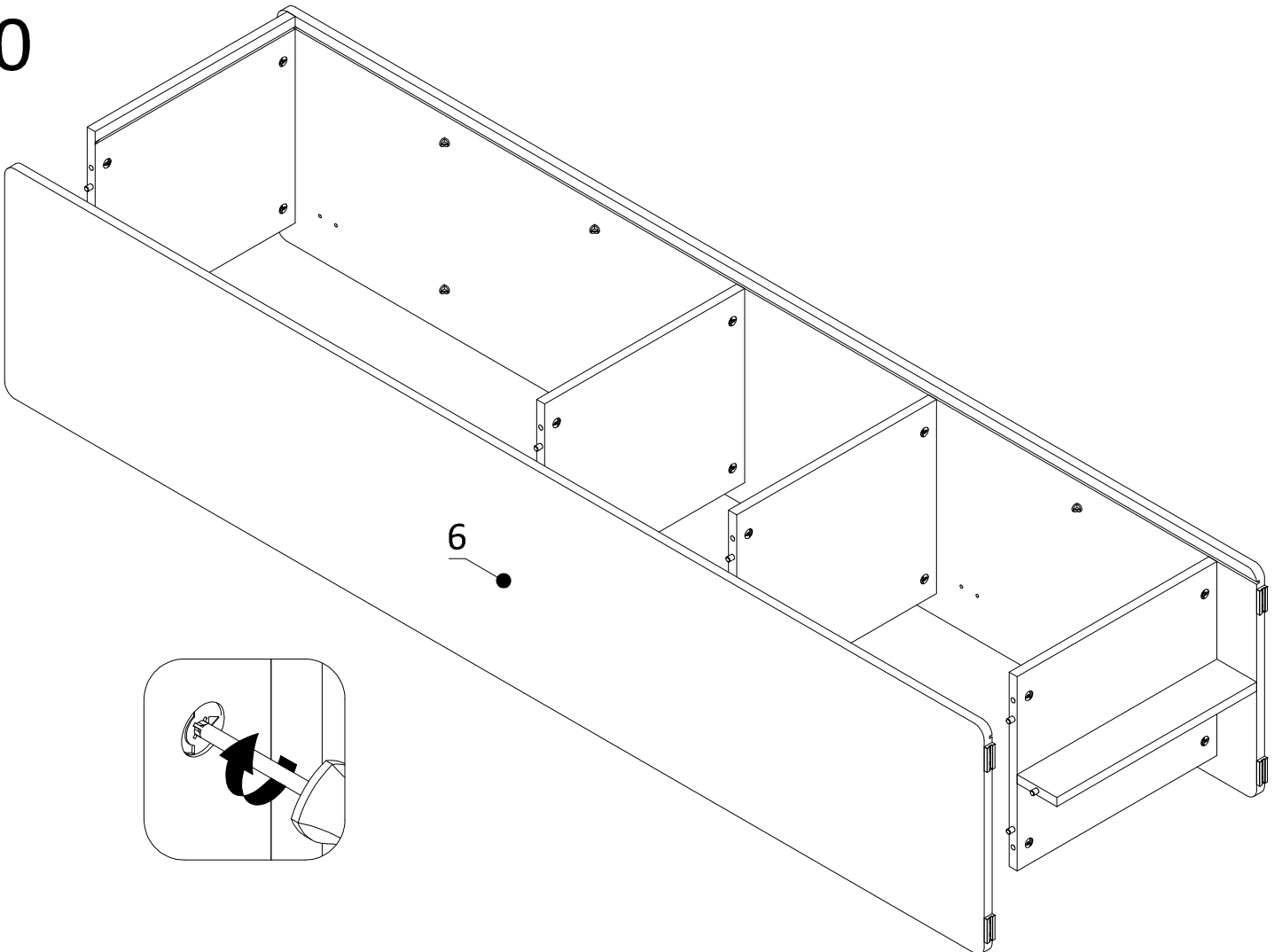

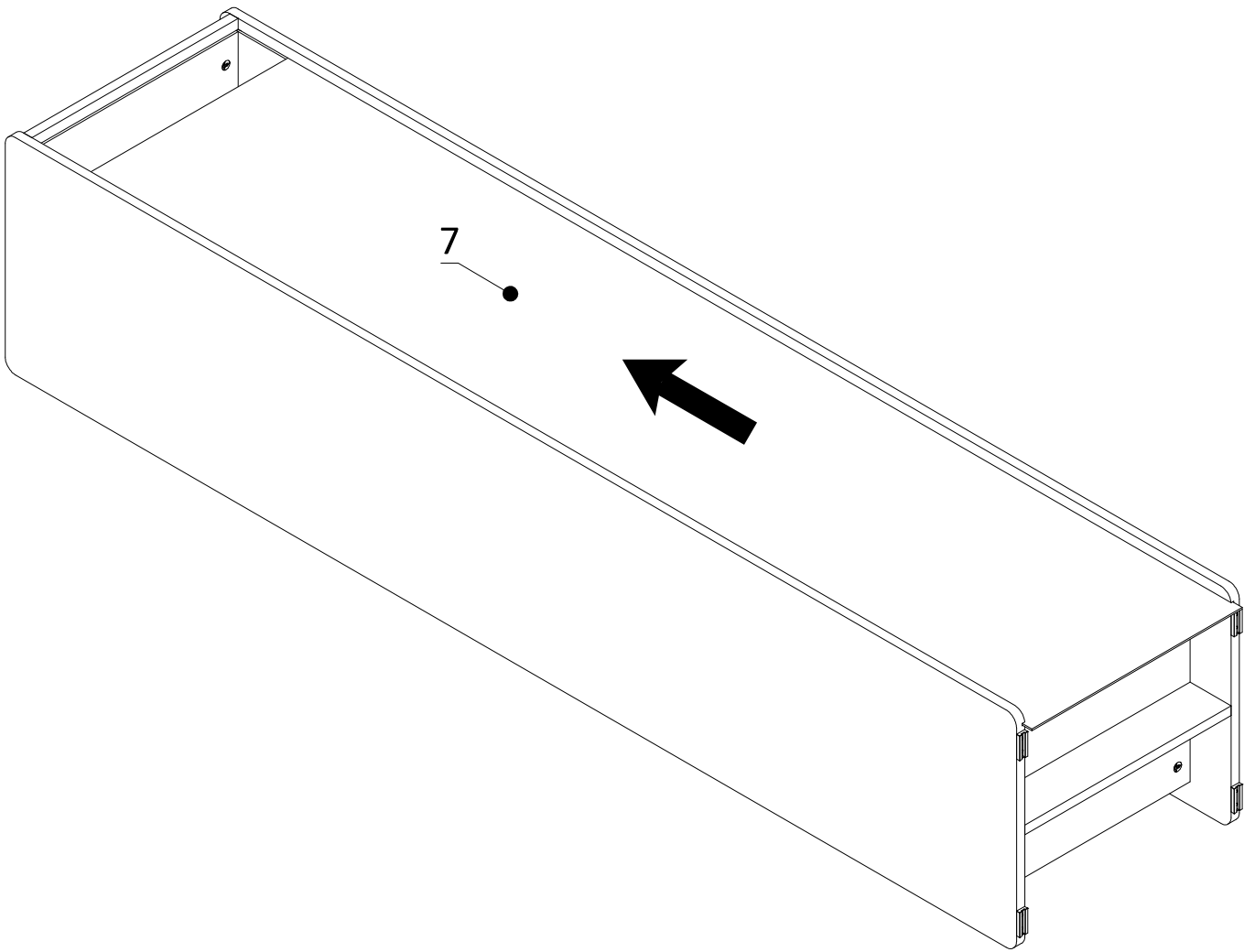

11

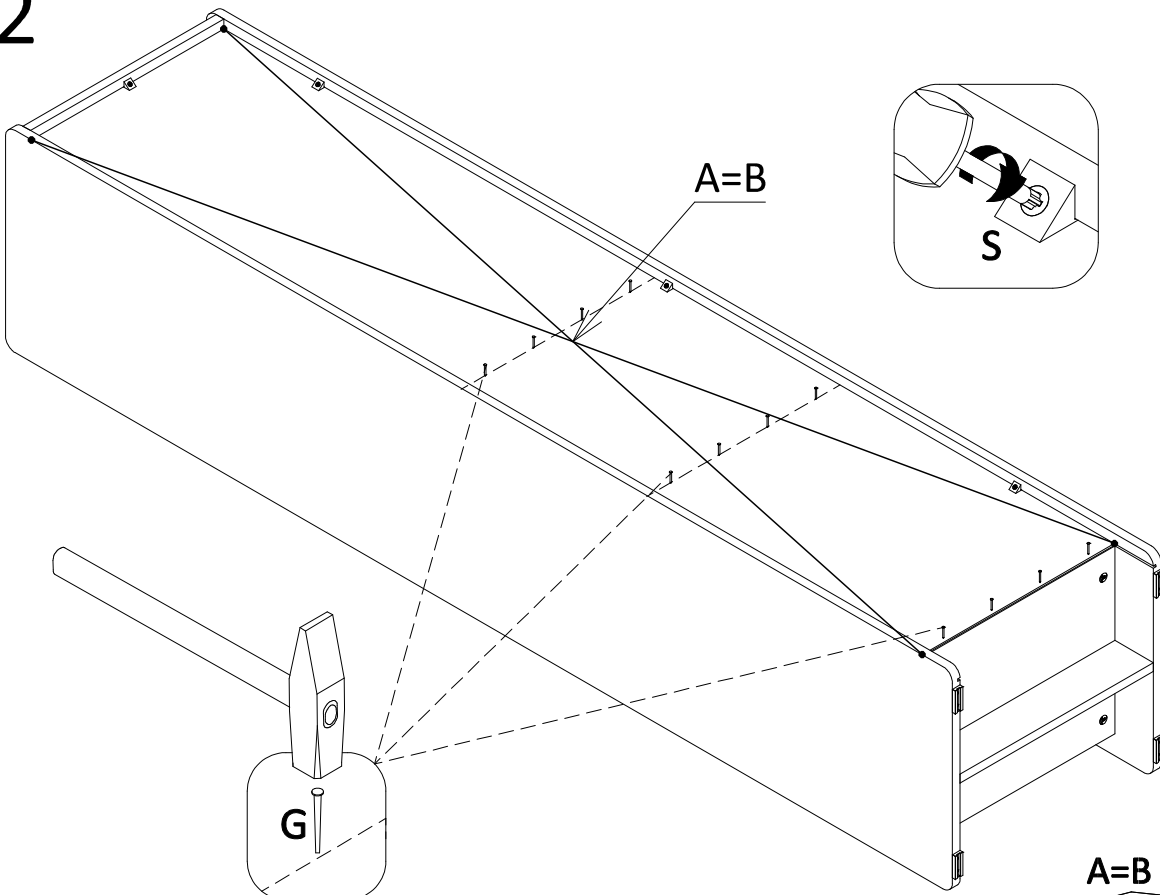

12



	
G	S
12x	7x

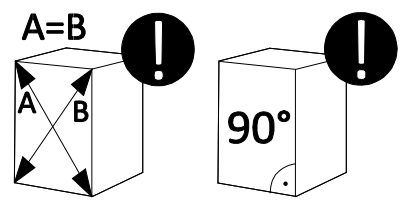

13

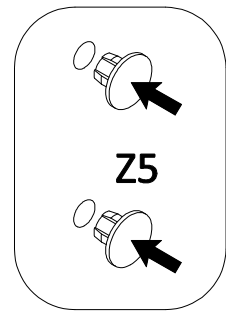
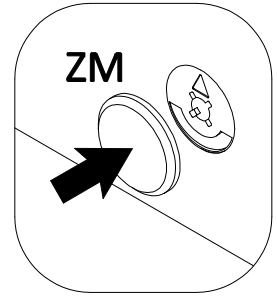
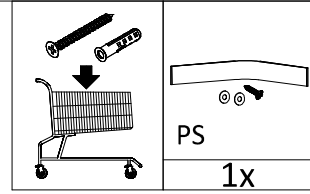
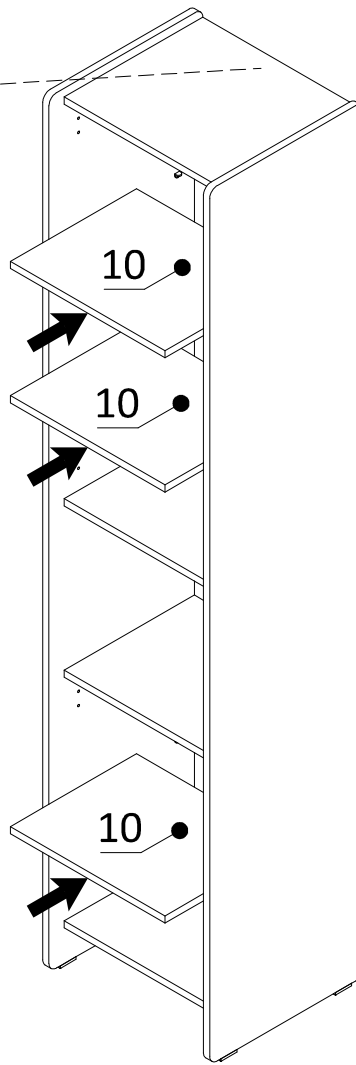
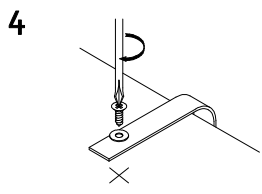
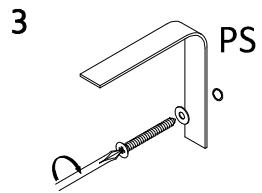
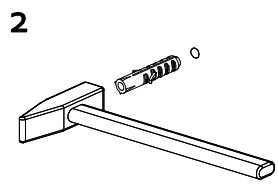
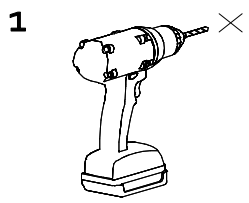

14

